

ASSEMBLY INSTRUCTIONS CHANGING STATION

HARDWARE

Screw 1 1/4" (32 mm) (2pcs)

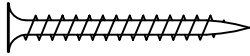

Screw Driver (Not Included)

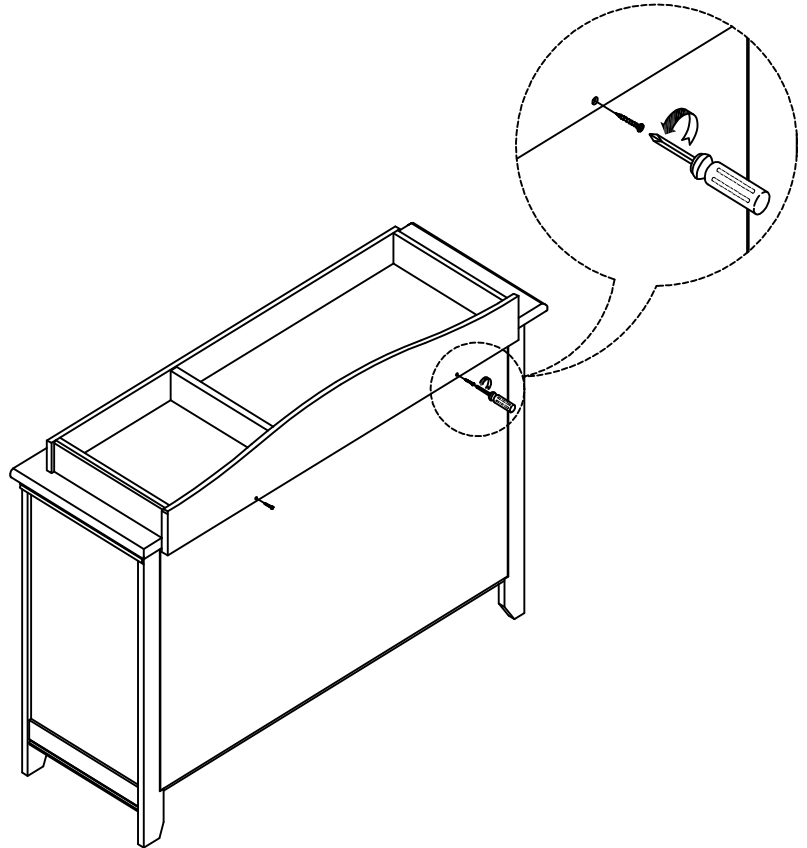
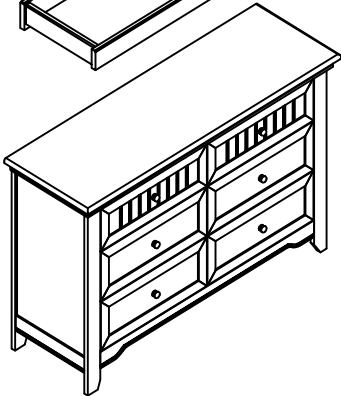
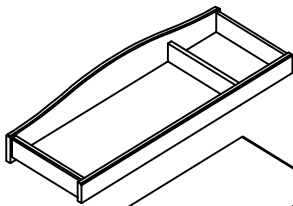
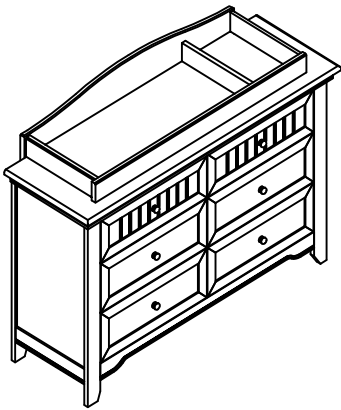
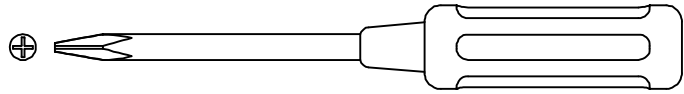

B. Insert the screws into the back of the changing station and combo or dresser, tighten with Phillip Head Screw driver. Check to see that the Changing Station is secure.

A. Place the changing station on the top of the Combo or Dresser. The holes in back side should be below the Combo or Dresser top surface. (see diagram).

NOTE : - ATTACH CHANGING STATION TO COMBO OR DRESSER.
- COMBO OR DRESSER MIGHT BE DIFFERENT THAN THE PICTURE

 **“CAUTION: ANY PAD USED IN THIS CHANGING STATION MUST BE AT LEAST 16 INCHES BY 32 INCHES (41 CM X 81 CM) WITH A THICKNESS NOT EXCEEDING 1 INCH (2.54 CM).**

 **WARNING!** FOR CHANGING STATION USE

- READ ALL INSTRUCTIONS BEFORE ASSEMBLING CHANGING STATION.

KEEP INSTRUCTIONS FOR FUTURE USE.

- FAILURE TO FOLLOW THESE WARNINGS AND THE ASSEMBLY INSTRUCTIONS COULD RESULT IN SERIOUS INJURY OR DEATH.
- **CAUTION** : THE PAD INTENDED FOR USE ON THE CHANGING STATION SHALL HAVE MINIMUM DIMENSIONS OF 16 INCHES BY 32 INCHES (41 CM X 81 CM) WITH A THICKNESS NOT EXCEEDING 1 INCH (2.54 CM).
- THE MAXIMUM WEIGHT SHALL NOT BE GREATER THAN 30 LB (13.6 KG)
- DO NOT USE CHANGING STATION IF IT IS DAMAGED OR BROKEN.
- PLEASE CLEAN THE CHANGING STATION WITH A DRY CLOTH AND USE MILD WOOD POLISH IF REQUIRED.

FALL HAZARD:

- TO PREVENT DEATH OR SERIOUS INJURY, ALWAYS KEEP CHILD WITHIN ARM'S REACH.
- ALWAYS SECURE THIS CHANGING STATION TO THE CHANGING SURFACE BY ATTACHING IT USING THE SCREWS PROVIDED. SEE INSTRUCTIONS.
- THE SURFACE USED SHOULD BE LEVEL, STABLE AND STRUCTURALLY SOUND WITH MINIMUM SURFACE DIMENSIONS OF 45.25 INCHES (114.93 CM) BY 17.25 INCHES (43.81 CM).