

# ASSEMBLY INSTRUCTIONS

Conversion Kit

VENETIAN

Model # 11270

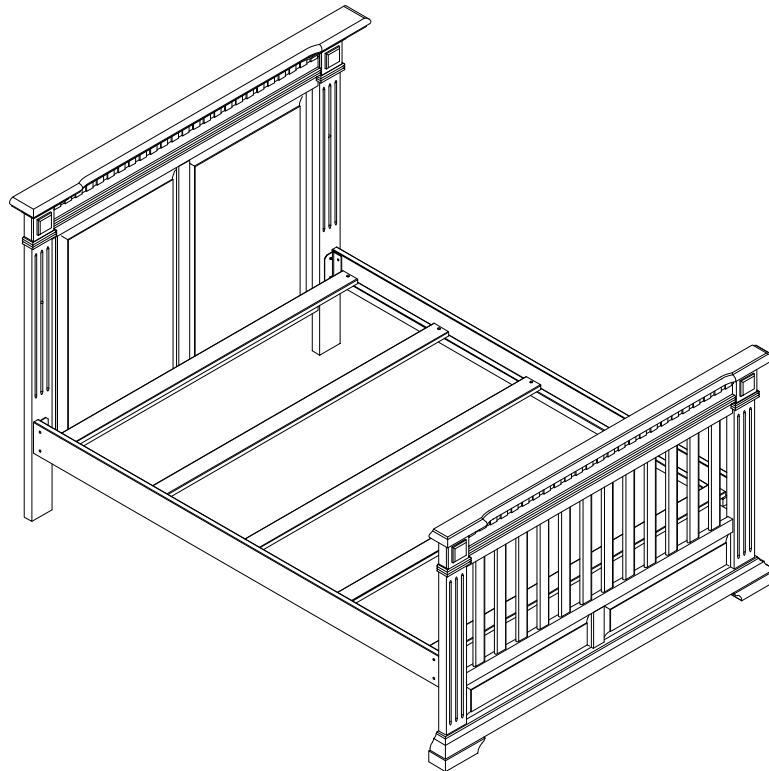

" RECOMMENDATION: We recommend the use of a Bunkie Board or box spring under a mattress for this conversion kit."

Carefully remove and lay out all parts. Familiarize yourself with all exhibits and diagrams to facilitate the assembly of your crib

**TOOLS REQUIRED :**

Allenkey (supplied)

Screw Driver (Unsupplied)

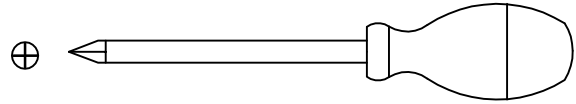
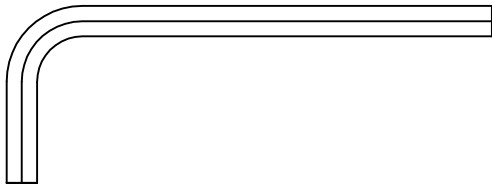

**PART ENCLOSED IN CARTON**

A. Rails ( 2 pcs )

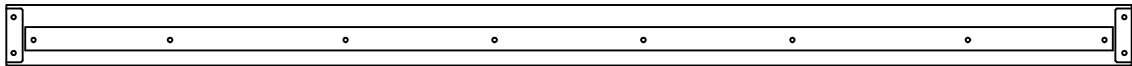

B. Slat ( 5 pcs )

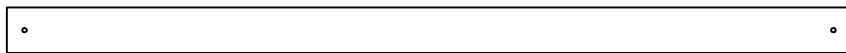

**HARDWARE**

C. Allenbolt 1 3/8" ( 35 mm ) ( 4 pcs )

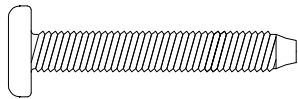

L. Nut 3/4" ( 20 mm ) ( 6 pcs )

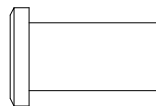

D. Allenbolt 3/4" ( 20 mm ) ( 4 pcs )

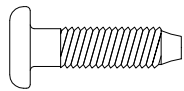

W. Spring Washer ( 8 pcs )

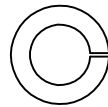

J. Allenbolt 1" ( 25 mm ) ( 2 pcs )



N. Allenkey ( 2 pcs ) (length may vary )



G. Screw 1 1/4" ( 30 mm ) ( 10 pcs )

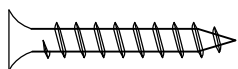

Make sure the bolts are tightly locked against the washers during assembly.  
 ( Please add an extra 1/2 revolution to all the bolts when using spring washer after tightening)

## STEP 1 " ASSEMBLY OF HEAD BOARD "

### THIS STEP REQUIRES :

Headboard ( 1 pc )

A. Rails ( 2 pcs )

N. Allenkey ( 2 pcs )

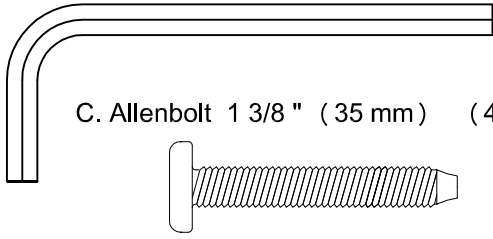

C. Allenbolt 1 3/8 " ( 35 mm ) ( 4 pcs ) W. Spring Washer ( 4 pcs ) L. Nut 3/4" ( 20 mm ) ( 4 pcs )

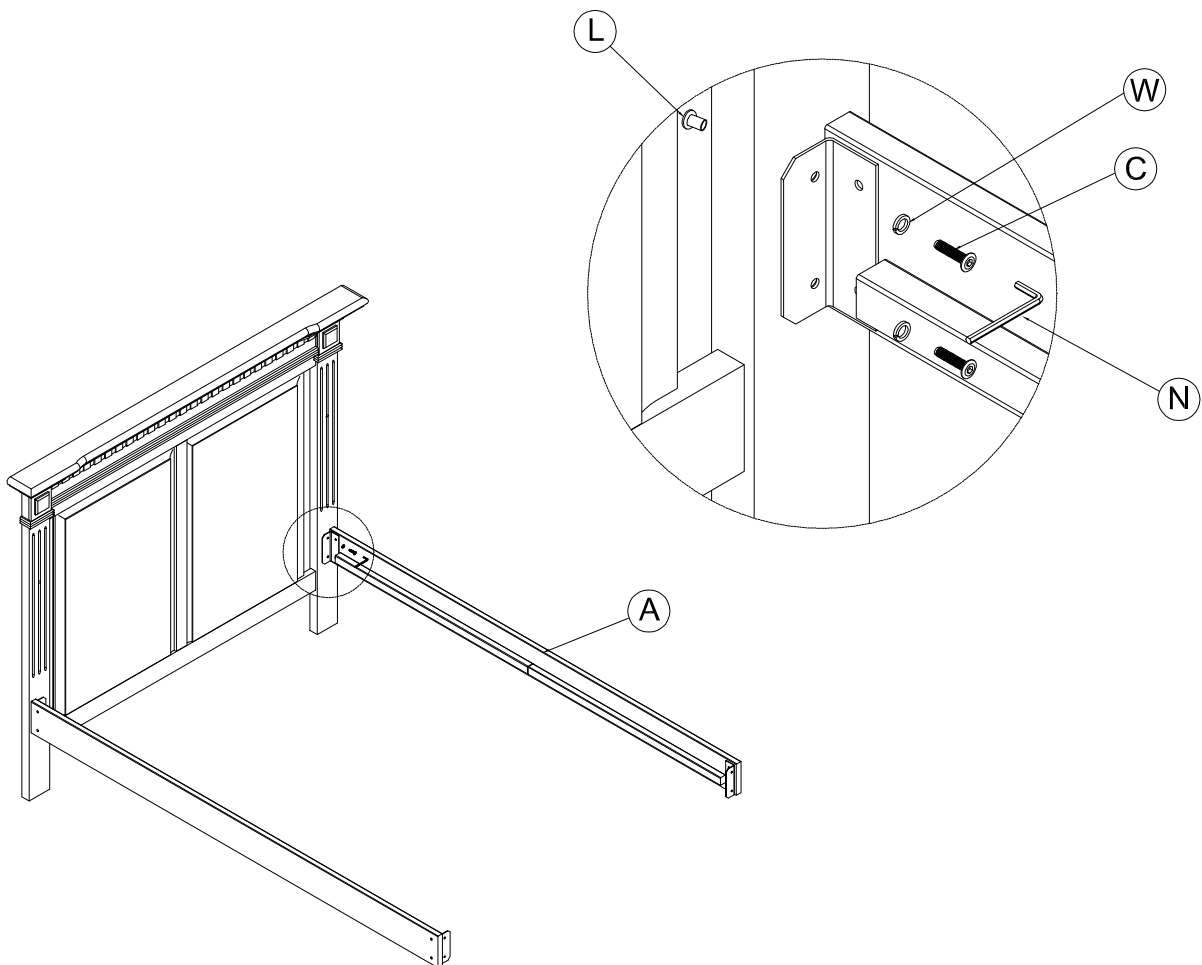
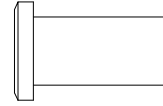
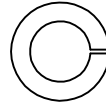

- Insert Allenbolt 1 3/8 " ( 35 mm ) ( C ) with spring washer ( W ) through the metal bracket holes in the end of side rail through the top & bottom holes in headboard and connect with nut 3/4" ( 20 mm ) ( L ).  
Hand tighten only

## STEP 2 " ASSEMBLY OF FOOTBOARD "

### THIS STEP REQUIRES :

Footboard ( 1 pc)

N. Allenkey ( 2 pcs)

J. Allenbolt 1" ( 25 mm ) ( 2 pcs )

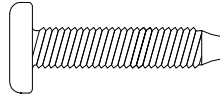

D. Allenbolt 3/4" ( 20 mm ) ( 4 pcs )

L. Nut 3/4" ( 20 mm ) ( 2 pcs )

W. Spring Washer ( 4 pcs )

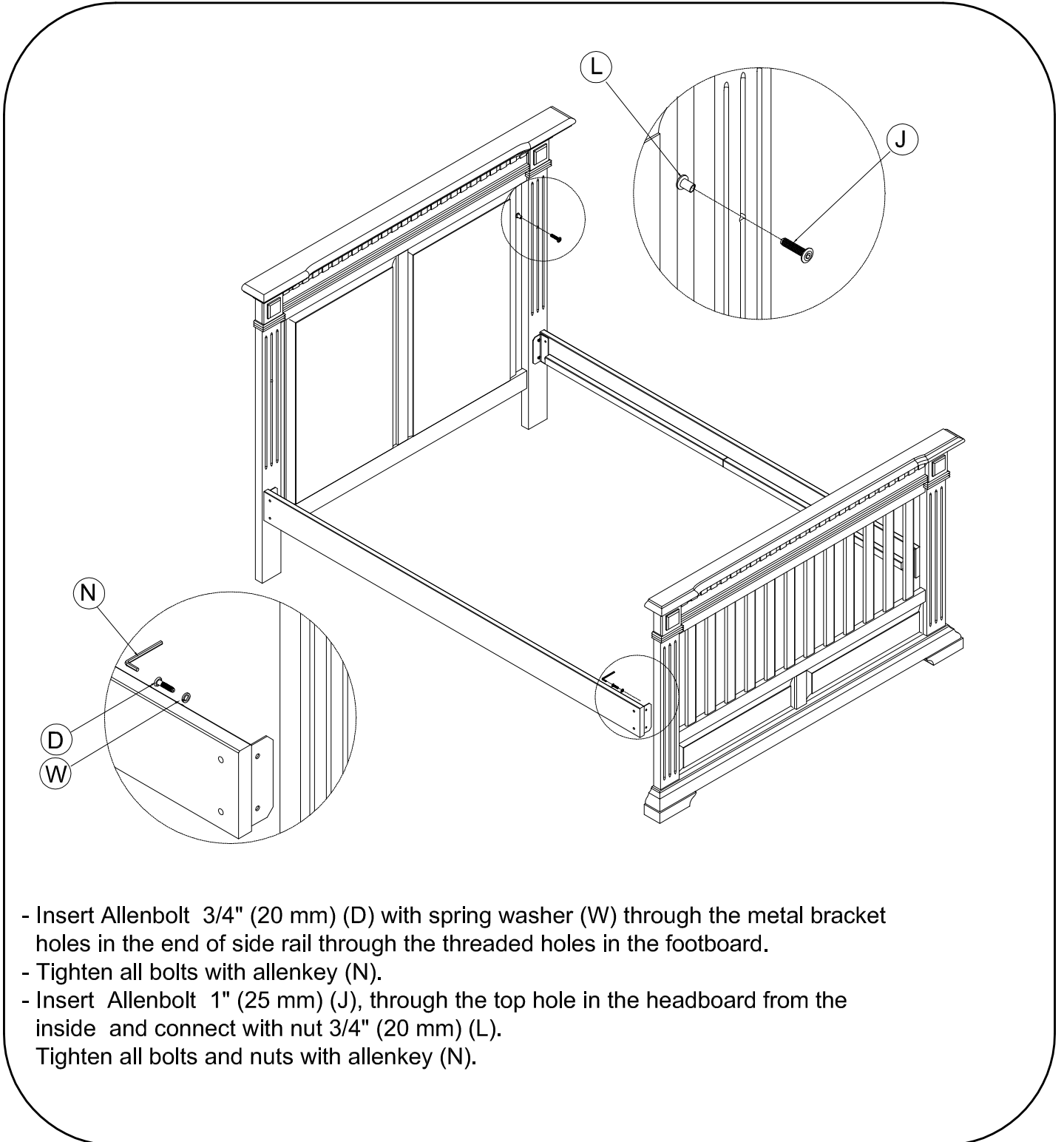
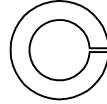
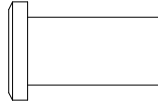
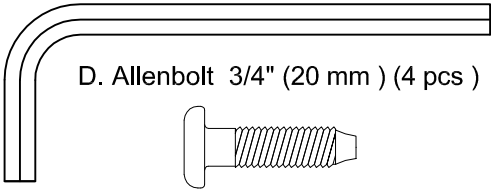

- Insert Allenbolt 3/4" ( 20 mm ) ( D ) with spring washer ( W ) through the metal bracket holes in the end of side rail through the threaded holes in the footboard.
- Tighten all bolts with allenkey ( N ).
- Insert Allenbolt 1" ( 25 mm ) ( J ), through the top hole in the headboard from the inside and connect with nut 3/4" ( 20 mm ) ( L ).
- Tighten all bolts and nuts with allenkey ( N ).

## STEP 3 " ASSEMBLY OF SLATS "

### THIS STEP REQUIRES :

B. Slats ( 5 pcs)

G. Screw 1 1/4 " ( 30 mm ) ( 10 pcs )

Screw Driver  
( Unsupplied )

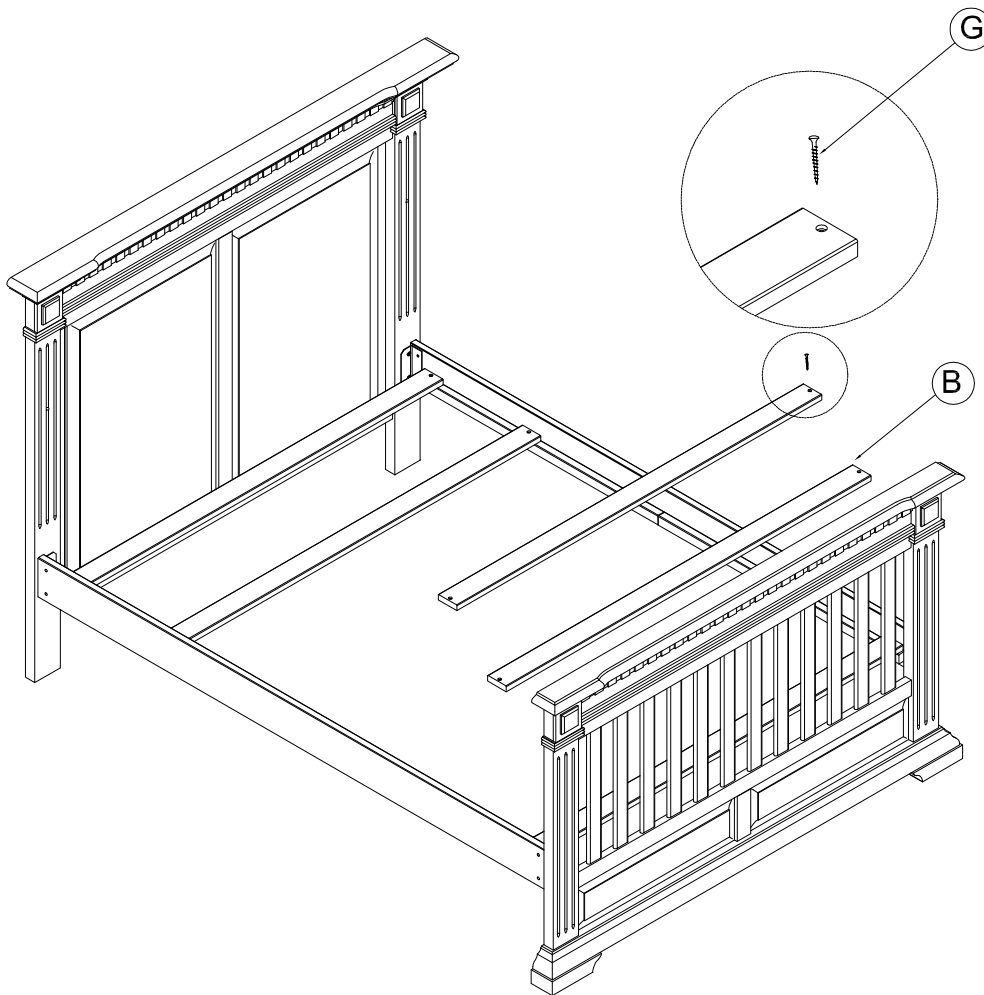
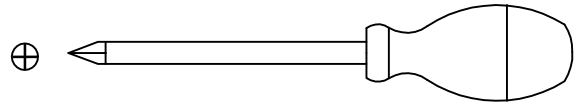
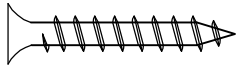

- Install 5 pcs of slats (B) to the 2 pcs of side rail above the pre drilling holes.
- Insert 10 pcs of screw 1 1/4 " ( 30 mm ) ( G ) screws into the slats holes through side rail pre drilling holes. Hand tighten only
- After all 10 pcs of screw inserted, fasten with screw driver.